























































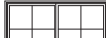

GLIDER

Operator Units

Masonry Opening	2' - 6" (762)	3' - 0" (914)	3' - 6" (1067)	4' - 0" (1219)	4' - 6" (1372)	5' - 0" (1524)	6' - 0" (1829)
Rough Opening	2' - 6" (762)	3' - 0" (914)	3' - 6" (1067)	4' - 0" (1219)	4' - 6" (1372)	5' - 0" (1524)	6' - 0" (1829)
Frame Size	2' - 5 1/2" (749)	2' - 11 1/2" (902)	3' - 5 1/2" (1054)	3' - 11 1/2" (1207)	4' - 5 1/2" (1359)	4' - 11 1/2" (1511)	5' - 11 1/2" (1816)
Glass Size	12 7/16" (316)	15 7/16" (392)	18 7/16" (468)	21 7/16" (545)	24 7/16" (621)	27 7/16" (697)	33 7/16" (849)













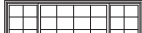
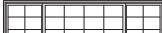
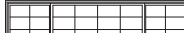



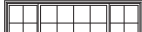

1' - 5 3/4" (451) 1' - 6" (457) 1' - 5 1/2" (445) 13 11/16" (347)	 IFGL2616	 IFGL3016	 IFGL3616	 IFGL4016	 IFGL4616	 IFGL5016	 IFGL6016
1' - 11 3/4" (603) 2' - 0" (610) 1' - 11/2" (597) 19 11/16" (500)	 IFGL2620	 IFGL3020	 IFGL3620	 IFGL4020	 IFGL4620	 IFGL5020	 IFGL6020
2' - 5 3/4" (756) 2' - 6" (762) 2' - 5 1/2" (749) 25 11/16" (652)	 IFGL2626	 IFGL30126	 IFGL36126	 IFGL4026	 IFGL4626	 IFGL5026	 IFGL6026
2' - 11 3/4" (908) 3' - 0" (914) 2' - 11 1/2" (902) 31 11/16" (805)	 IFGL2630	 IFGL3030	 IFGL3630	 IFGL4030	 IFGL4630	 IFGL5030	 IFGL6030
3' - 5 3/4" (1060) 3' - 6" (1067) 3' - 5 1/2" (1054) 37 11/16" (957)	 IFGL2636	 IFGL3036	 IFGL3636	 IFGL4036	 IFGL4636 E	 IFGL5036 E	 IFGL6036 E
3' - 11 3/4" (1213) 4' - 0" (1219) 3' - 11 1/2" (1207) 43 11/16" (1109)	 IFGL2640	 IFGL3040	 IFGL3640	 IFGL4040 E	 IFGL4640 E	 IFGL5040 E	 IFGL6040 E
4' - 5 3/4" (1365) 4' - 6" (1372) 4' - 5 1/2" (1359) 49 11/16" (1262)	 IFGL2646	 IFGL3046	 IFGL3646	 IFGL4046 E	 IFGL4646 E	 IFGL5046 E	 IFGL6046 E
4' - 11 3/4" (1518) 5' - 0" (1524) 4' - 11 1/2" (1511) 55 11/16" (1414)	 IFGL2650	 IFGL3050	 IFGL3650	 IFGL4050 E	 IFGL4650 E	 IFGL5050 E	 IFGL6050 E

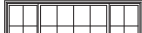
GLIDER

INTEGRITY® FROM MARVIN®
ALL ULTREX® SERIES

Operator Units

Masonry Opening	6'-0" (1829)	7'-0" (2134)	8'-0" (2438)
Rough Opening	6'-0" (1829)	7'-0" (2134)	8'-0" (2438)
Frame Size	5'-11 1/2" (1816)	6'-11 1/2" (2121)	7'-11 1/2" (2426)

1'-5 3/4" (451) 1'-6" (457) 1'-5 1/2" (445)			
IFGLTS6016	IFGLTS7016	IFGLTS8016	
1'-11 3/4" (603) 2'-0" (610) 1'-11 1/2" (597)			
IFGLTS6020	IFGLTS7020	IFGLTS8020	
2'-5 3/4" (756) 2'-6" (762) 2'-5 1/2" (749)			
IFGLTS6026	IFGLTS7026	IFGLTS8026	
2'-11 3/4" (908) 3'-0" (914) 2'-11 1/2" (902)			
IFGLTS6030	IFGLTS7030	IFGLTS8030	
3'-5 3/4" (1060) 3'-6" (1067) 3'-5 1/2" (1054)			
IFGLTS6036	IFGLTS7036	IFGLTS8036	
3'-11 3/4" (1213) 4'-0" (1219) 3'-11 1/2" (1207)			
IFGLTS6040	IFGLTS7040	IFGLTS8040	
4'-5 3/4" (1365) 4'-6" (1372) 4'-5 1/2" (1359)			
IFGLTS6046	IFGLTS7046	IFGLTS8046	
4'-11 3/4" (1518) 5'-0" (1524) 4'-11 1/2" (1511)			
IFGLTS6050	IFGLTS7050	IFGLTS8050	

GBG available in standard Rectangular lite cut shown.

E = These windows meet National Egress Codes for fire evacuation. Local codes may differ.

Details and Elevations not to scale.

Obscure Glass option available on all units.

Special sized units available within productsize matrix. See your Integrity retailer.

Multiple Assemblies

Multiple assemblies can be factory mullied.

MAXIMUM ROUGH OPENING not to exceed 114" X 60" Maximum up to 3 units wide by 1 unit high

MAXIMUM ROUGH OPENING not to exceed 72" X 78" Maximum up to 2 units wide by 2 units high

Field mull kits are available. Structural mullion reinforcement is required for some assemblies.

Please consult your local Integrity from Marvin® representative for more information.

Construction Details

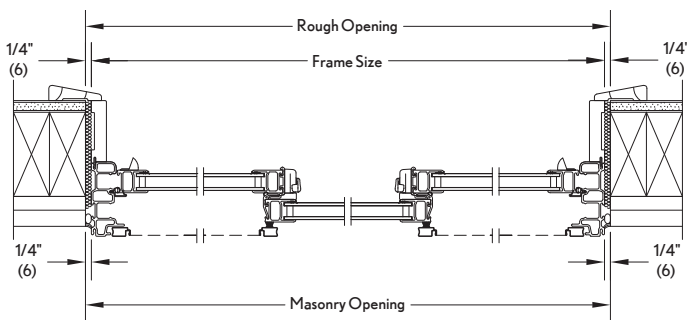
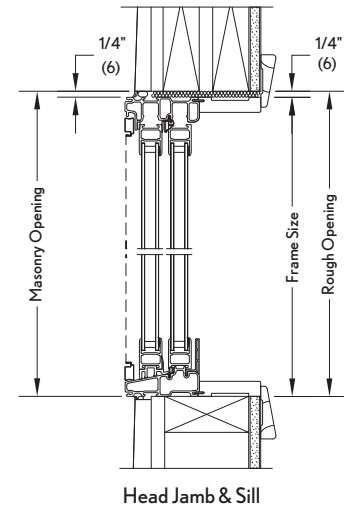

Triple Sash XOX Operator Jamb

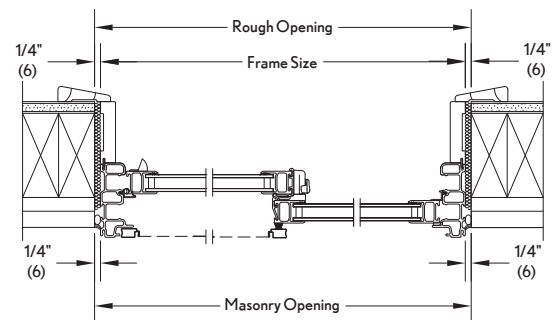



















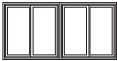





















Jamb

GLIDER

2 Wide Operator Units

Masonry Opening	5' - 0" (1524)	6' - 0" (1828)	7' - 0" (2134)	8' - 0" (2438)	9' - 0" (2744)
Rough Opening	5' - 0" (1524)	6' - 0" (1828)	7' - 0" (2134)	8' - 0" (2438)	9' - 0" (2744)
Frame Size	4' - 11 1/2" (1511)	5' - 11 1/2" (1816)	6' - 11 1/2" (2121)	7' - 11 1/2" (2426)	8' - 11 1/2" (2734)

1' - 5 3/4" (451) 1' - 6" (457) 1' - 5 1/2" (445)	 IFGL2616	 IFGL3016	 IFGL3616	 IFGL4016	 IFGL4616
1' - 11 3/4" (603) 2' - 0" (610) 1' - 11 1/2" (597)	 IFGL2620	 IFGL3020	 IFGL3620	 IFGL4020	 IFGL4620
2' - 5 3/4" (756) 2' - 6" (762) 2' - 5 1/2" (749)	 IFGL2626	 IFGL30126	 IFGL36126	 IFGL4026	 IFGL4626
2' - 11 3/4" (908) 3' - 0" (914) 2' - 11 1/2" (902)	 IFGL2630	 IFGL3030	 IFGL3630	 IFGL4030	 IFGL4630
3' - 5 3/4" (1060) 3' - 6" (1067) 3' - 5 1/2" (1054)	 IFGL2636	 IFGL3036	 IFGL3636	 IFGL4036	 IFGL4636 E
3' - 11 3/4" (1213) 4' - 0" (1219) 3' - 11 1/2" (1207)	 IFGL2640	 IFGL3040	 IFGL3640	 IFGL4040 E	 IFGL4640 E
4' - 5 3/4" (1365) 4' - 6" (1372) 4' - 5 1/2" (1359)	 IFGL2646	 IFGL3046	 IFGL3646	 IFGL4046 E	 IFGL4646 E
4' - 11 3/4" (1518) 5' - 0" (1524) 4' - 11 1/2" (1511)	 IFGL2650	 IFGL3050	 IFGL3650	 IFGL4050 E	 IFGL4650 E

GBG available in standard Rectangular lite cut shown.

E = These windows meet National Egress Codes for fire evacuation. Local codes may differ.

Details and Elevations not to scale.

Obscure Glass option available on all units.

Special sized units available within product size matrix. See your Integrity retailer.

Multiple Assemblies

Multiple assemblies can be factory mullied.

MAXIMUM ROUGH OPENING not to exceed 114" X 60" Maximum up to 3 units wide by 1 unit high

MAXIMUM ROUGH OPENING not to exceed 72" X 78" Maximum up to 2 units wide by 2 units high

Field mull kits are available. Structural mullion reinforcement is required for some assemblies.

Please consult your local Integrity from Marvin® representative for more information.

Construction Details

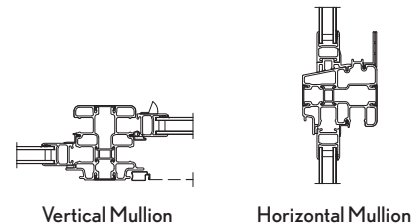

Vertical Mullion









































































Horizontal Mullion

SLIDING PICTURE UNITS

INTEGRITY® FROM MARVIN®
ALL ULTREX® SERIES

Picture Units

Masonry Opening	1'-6" (457)	2'-0" (610)	2'-6" (762)	2'-8" (914)	3'-0" (914)	3'-6" (1067)	4'-0" (1219)	5'-0" (1524)
Rough Opening	1'-6" (457)	2'-0" (610)	2'-6" (762)	2'-8" (914)	3'-0" (914)	3'-6" (1067)	4'-0" (1219)	5'-0" (1524)
Frame Size	1'-5 1/2" (445)	1'-11 1/2" (597)	2'-5 1/2" (749)	2'-7 1/2" (902)	2'-11 1/2" (902)	3'-5 1/2" (1054)	3'-11 1/2" (1207)	4'-11 1/2" (1511)
Glass Size	13 17/32" (344)	19 17/32" (496)	25 17/32" (649)	27 11/16" (804)	31 17/32" (801)	37 17/32" (953)	43 17/32" (1106)	55 17/32" (1411)

1'-11 3/4" (603) 2'-0" (610) 1'-11 1/2" (597) 2 11/32" (54)								
IFSLP1620	IFSLP2020	IFSLP2620	IFSLP2820	IFSLP3020	IFSLP3620	IFSLP4020	IFSLP5020	
2'-5 3/4" (756) 2'-6" (762) 2'-5 1/2" (749) 2 17/32" (699)								
IFSLP1626	IFSLP2026	IFSLP2626	IFSLP2826	IFSLP3026	IFSLP3626	IFSLP4026	IFSLP5026	
2'-11 3/4" (908) 3'-0" (914) 2'-11 1/2" (902) 3 17/32" (801)								
IFSLP1630	IFSLP2030	IFSLP2630	IFSLP2830	IFSLP3030	IFSLP3630	IFSLP4030	IFSLP5030	
3'-5 3/4" (1060) 3'-6" (1067) 3'-5 1/2" (1054) 3 17/32" (953)								
IFSLP1636	IFSLP2036	IFSLP2636	IFSLP2836	IFSLP3036	IFSLP3636	IFSLP4036	IFSLP5036	
3'-11 3/4" (1213) 4'-0" (1219) 3'-11 1/2" (1207) 4 31/32" (1106)								
IFSLP1640	IFSLP2040	IFSLP2640	IFSLP2840	IFSLP3040	IFSLP3640	IFSLP4040	IFSLP5040	
4'-5 3/4" (1365) 4'-6" (1372) 4'-5 1/2" (1359) 4 17/32" (1258)								
IFSLP1646	IFSLP2046	IFSLP2646	IFSLP2846	IFSLP3046	IFSLP3646	IFSLP4046	IFSLP5046	
4'-11 3/4" (1518) 5'-0" (1524) 4'-11 1/2" (1511) 5 17/32" (1411)								
IFSLP1650	IFSLP2050	IFSLP2650	IFSLP2850	IFSLP3050	IFSLP3650	IFSLP4050	IFSLP5050	
5'-5 3/4" (1670) 5'-6" (1676) 5'-5 1/2" (1664) 6 17/32" (1563)								
IFSLP1656	IFSLP2056	IFSLP2656	IFSLP2856	IFSLP3056	IFSLP3656	IFSLP4056	IFSLP5056	
5'-11 3/4" (1822) 6'-0" (1829) 5'-11 1/2" (1816) 6 17/32" (1715)								
IFSLP1660	IFSLP2060	IFSLP2660	IFSLP2860	IFSLP3060	IFSLP3660	IFSLP4060	IFSLP5060	

SLIDING PICTURE AND TRANSOM UNITS

In-Sash Transom

Masonry Opening	1' - 6" (457)	2' - 0" (610)	2' - 6" (762)	2' - 8" (914)	3' - 0" (914)	3' - 6" (1067)	4' - 0" (1219)	5' - 0" (1524)
Rough Opening	1' - 6" (457)	2' - 0" (610)	2' - 6" (762)	2' - 8" (914)	3' - 0" (914)	3' - 6" (1067)	4' - 0" (1219)	5' - 0" (1524)
Frame Size	1' - 5 1/2" (445)	1' - 11 1/2" (597)	2' - 5 1/2" (749)	2' - 7 1/2" (902)	2' - 11 1/2" (902)	3' - 5 1/2" (1054)	3' - 11 1/2" (1207)	4' - 11 1/2" (1511)
Glass Size	13 17/32" (344)	19 17/32" (496)	25 17/32" (649)	27 11/16" (804)	31 17/32" (801)	37 17/32" (953)	43 17/32" (1106)	55 17/32" (1411)

0' - 11 3/4" (298)								
1' - 5 3/4" (451)								
1' - 11 3/4" (603)								

Construction Details

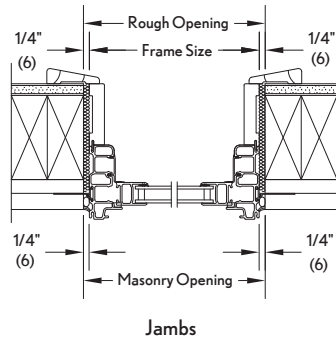
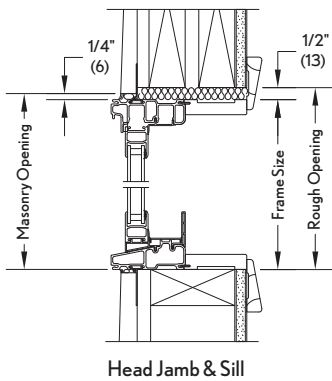

GBG available in standard Rectangular lite cut, shown. (Not available on In-Sash Transom units.)

Details and Elevations not to scale.

Multiple Assemblies

Multiple assemblies can be factory mullied.

MAXIMUM ROUGH OPENING not to exceed 114" X 78" Maximum up to 6 units wide by 1 unit high

MAXIMUM ROUGH OPENING not to exceed 96" X 96" Maximum up to 5 units wide by 5 units high

Field mull kits are available. Structural mullion reinforcement is required for some assemblies.

Please consult your local Integrity from Marvin® representative for more information.