







































































DOUBLE HUNG







































































INTEGRITY® FROM MARVIN®
ALL ULTREX® SERIES

Operator Units

Masonry Opening	1'-6" (457)	2'-0" (610)	2'-6" (762)	2'-8" (914)	3'-0" (914)	3'-6" (1067)	4'-0" (1219)
Rough Opening	1'-6" (457)	2'-0" (610)	2'-6" (762)	2'-8" (914)	3'-0" (914)	3'-6" (1067)	4'-0" (1219)
Frame Size	1'-5 1/2" (445)	1'-11 1/2" (597)	2'-5 1/2" (749)	2'-7 1/2" (902)	2'-11 1/2" (902)	3'-5 1/2" (1054)	3'-11 1/2" (1207)
Glass Size	13 17/32" (344)	19 17/32" (496)	25 17/32" (649)	27 17/32" (703)	31 17/32" (801)	37 17/32" (953)	43 17/32" (1106)
1'-11 3/4" (603)	 IFDH1620	 IFDH2020	 IFDH2620	 IFDH2820	 IFDH3020	 IFDH3620	 IFDH4020
2'-5 3/4" (756)	 IFDH1626	 IFDH2026	 IFDH2626	 IFDH2826	 IFDH3026	 IFDH3626	 IFDH4026
2'-11 3/4" (908)	 IFDH1630	 IFDH2030	 IFDH2630	 IFDH2830	 IFDH3030	 IFDH3630	 IFDH4030
3'-5 3/4" (1060)	 IFDH1636	 IFDH2036	 IFDH2636	 IFDH2836	 IFDH3036	 IFDH3636	 IFDH4036
3'-11 3/4" (1213)	 IFDH1640	 IFDH2040	 IFDH2640	 IFDH2840	 IFDH3040	 IFDH3640	 IFDH4040
4'-5 3/4" (1365)	 IFDH1646	 IFDH2046	 IFDH2646	 IFDH2846	 IFDH3046	 IFDH3646	 IFDH4046
4'-11 3/4" (1518)	 IFDH1650	 IFDH2050	 IFDH2650	 IFDH2850	 IFDH3050 E	 IFDH3650 E	 IFDH4050 E
5'-5 3/4" (1670)	 IFDH1656	 IFDH2056	 IFDH2656	 IFDH2856	 IFDH3056 E	 IFDH3656 E	 IFDH4056 E
5'-11 3/4" (1822)	 IFDH1660	 IFDH2060	 IFDH2660	 IFDH2860 E	 IFDH3060 E	 IFDH3660 E	 IFDH4060 E
6'-5 3/4" (1975)	 IFDH1666	 IFDH2066	 IFDH2666 E	 IFDH2866 E	 IFDH3066 E	 IFDH3666 E	 IFDH4066 E

DOUBLE HUNG





























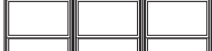



















2 Wide Operator Units

Masonry Opening	3' - 0" (914)	4' - 0" (1219)	5' - 0" (1524)	5' - 4" (1626)	6' - 0" (1829)	7' - 0" (2134)	8' - 0" (2438)
Rough Opening	3' - 0" (914)	4' - 0" (1219)	5' - 0" (1524)	5' - 4" (1626)	6' - 0" (1829)	7' - 0" (2134)	8' - 0" (2438)
Frame Size	2' - 11 1/2" (902)	3' - 11 1/2" (1207)	4' - 11 1/2" (1511)	5' - 3 1/2" (1600)	5' - 11 1/2" (1816)	6' - 11 1/2" (2121)	7' - 11 1/2" (2426)
1' - 11 3/4" (603) 2' - 0" (610) 2' - 5 1/2" (749) 2' - 9 3/32" (236)	 IFDH1620	 IFDH2020	 IFDH2620	 IFDH2820	 IFDH3020	 IFDH3620	 IFDH4020
2' - 5 3/4" (756) 2' - 6" (762) 2' - 5 1/2" (749) 2' - 9 3/32" (312)	 IFDH1626	 IFDH2026	 IFDH2626	 IFDH2826	 IFDH3026	 IFDH3626	 IFDH4026
2' - 11 3/4" (908) 3' - 0" (914) 2' - 11 1/2" (902) 15 9/32" (388)	 IFDH1630	 IFDH2030	 IFDH2630	 IFDH2830	 IFDH3030	 IFDH3630	 IFDH4030
3' - 5 3/4" (1060) 3' - 6" (1067) 3' - 5 1/2" (1054) 18 9/32" (464)	 IFDH1636	 IFDH2036	 IFDH2636	 IFDH2836	 IFDH3036	 IFDH3636	 IFDH4036
3' - 11 3/4" (1213) 4' - 0" (1219) 3' - 11 1/2" (1207) 21 9/32" (541)	 IFDH1640	 IFDH2040	 IFDH2640	 IFDH2840	 IFDH3040	 IFDH3640	 IFDH4040
4' - 5 3/4" (1365) 4' - 6" (1372) 4' - 5 1/2" (1359) 24 9/32" (617)	 IFDH1646	 IFDH2046	 IFDH2646	 IFDH2846	 IFDH3046	 IFDH3646	 IFDH4046
4' - 11 3/4" (1518) 5' - 0" (1524) 4' - 11 1/2" (1511) 27 9/32" (693)	 IFDH1650	 IFDH2050	 IFDH2650	 IFDH2850	 IFDH3050 E	 IFDH3650 E	 IFDH4050 E
5' - 5 3/4" (1670) 5' - 6" (1676) 5' - 5 1/2" (1664) 30 9/32" (769)	 IFDH1656	 IFDH2056	 IFDH2656	 IFDH2856	 IFDH3056 E	 IFDH3656 E	 IFDH4056 E
5' - 11 3/4" (1822) 6' - 0" (1829) 5' - 11 1/2" (1816) 33 9/32" (845)	 IFDH1660	 IFDH2060	 IFDH2660	 IFDH2860 E	 IFDH3060 E	 IFDH3660 E	 IFDH4060 E
6' - 5 3/4" (1975) 6' - 6" (1981) 6' - 5 1/2" (1969) 36 9/32" (922)	 IFDH1666	 IFDH2066	 IFDH2666 E	 IFDH2866 E	 IFDH3066 E	 IFDH3666 E	 IFDH4066 E

DOUBLE HUNG





















INTEGRITY® FROM MARVIN®
ALL ULTREX® SERIES

3 Wide Operator Units

Masonry Opening	4' - 6" (1372)	6' - 0" (1829)	7' - 6" (2286)	8' - 0" (2438)	9' - 0" (2743)
Rough Opening	4' - 6" (1372)	6' - 0" (1829)	7' - 6" (2286)	8' - 0" (2438)	9' - 0" (2743)
Frame Size	4' - 5 1/2" (1359)	5' - 11 1/2" (1816)	7' - 5 1/2" (2273)	7' 11 1/2" (2413)	8' - 11 1/2" (2731)
1' - 11 3/4" (603) 2' - 0" (610) 2' - 6" (762) 2' - 5 1/2" (749) 1' - 11 1/2" (597) 9' 9/32" (236)	 IFDH1620	 IFDH2020	 IFDH2620	 IFDH2820	 IFDH3026
2' - 5 3/4" (756) 2' - 6" (762) 2' - 5 1/2" (749) 12' 9/32" (312)	 IFDH1626	 IFDH2026	 IFDH2626	 IFDH2826	 IFDH3026
2' - 11 3/4" (908) 3' - 0" (914) 2' - 11 1/2" (902) 15' 9/32" (388)	 IFDH1630	 IFDH2030	 IFDH2630	 IFDH2830	 IFDH3030
3' - 5 3/4" (1060) 3' - 6" (1067) 3' - 5 1/2" (1054) 18' 9/32" (464)	 IFDH1636	 IFDH2036	 IFDH2636	 IFDH2836	 IFDH3030
3' - 11 3/4" (1213) 4' - 0" (1219) 3' - 11 1/2" (1207) 21' 9/32" (541)	 IFDH1640	 IFDH2040	 IFDH2640	 IFDH2840	 IFDH3040
4' - 5 3/4" (1365) 4' - 6" (1372) 4' - 5 1/2" (1359) 24' 9/32" (617)	 IFDH1646	 IFDH2046	 IFDH2646	 IFDH2846	 IFDH3046
4' - 11 3/4" (1518) 5' - 0" (1524) 4' - 11 1/2" (1511) 27' 9/32" (693)	 IFDH1650	 IFDH2050	 IFDH2650	 IFDH2850	 IFDH3050 E
5' - 5 3/4" (1670) 5' - 6" (1676) 5' - 5 1/2" (1664) 30' 9/32" (769)	 IFDH1656	 IFDH2056	 IFDH2656	 IFDH2856	 IFDH3056 E
5' - 11 3/4" (1822) 6' - 0" (1829) 5' - 11 1/2" (1816) 33' 9/32" (845)	 IFDH1660	 IFDH2060	 IFDH2660	 IFDH2860 E	 IFDH3060 E
6' - 5 3/4" (1975) 6' - 6" (1981) 6' - 5 1/2" (1969) 36' 9/32" (922)	 IFDH1666	 IFDH2066	 IFDH2666 E	 IFDH2866 E	 IFDH3066 E

DOUBLE HUNG

4 Wide Operator Units

Masonry Opening	6' - 0" (1829)	8' - 0" (2438)
Rough Opening	6' - 0" (1829)	8' - 0" (2438)
Frame Size	5' - 11 1/2" (1816)	7' - 11 1/2" (2426)
1' - 11 3/4" (603) 2' - 0" (610) 1' - 11 1/2" (597) 9' 9/32" (236)	 IFDH1620	 IFDH2020
2' - 5 3/4" (756) 2' - 6" (762) 2' - 5 1/2" (749) 12' 9/32" (312)	 IFDH1626	 IFDH2026
2' - 11 3/4" (908) 3' - 0" (914) 2' - 11 1/2" (902) 15' 9/32" (388)	 IFDH1630	 IFDH2030
3' - 5 3/4" (1060) 3' - 6" (1067) 3' - 5 1/2" (1054) 18' 9/32" (464)	 IFDH1636	 IFDH2036
3' - 11 3/4" (1213) 4' - 0" (1219) 3' - 11 1/2" (1207) 21' 9/32" (541)	 IFDH1640	 IFDH2040
4' - 5 3/4" (1365) 4' - 6" (1372) 4' - 5 1/2" (1359) 24' 9/32" (617)	 IFDH1646	 IFDH2046
4' - 11 3/4" (1518) 5' - 0" (1524) 4' - 11 1/2" (1511) 27' 9/32" (693)	 IFDH1650	 IFDH2050
5' - 5 3/4" (1670) 5' - 6" (1676) 5' - 5 1/2" (1664) 30' 9/32" (769)	 IFDH1656	 IFDH2056
5' - 11 3/4" (1822) 6' - 0" (1829) 5' - 11 1/2" (1816) 33' 9/32" (845)	 IFDH1660	 IFDH2060
6' - 5 3/4" (1975) 6' - 6" (1981) 6' - 5 1/2" (1969) 36' 9/32" (922)	 IFDH1666	 IFDH2066

GBG available in standard Rectangular lite cut shown.

E = These windows (in equal sash) meet National Egress Codes for fire evacuation. Local codes may differ.

Details and Elevations not to scale.

Available in equal, cottage and reverse cottage sash configurations. Cottage and reverse cottage sash configurations are not available on 20, 60 and 66 call number heights.

Obscure Glass option available on all units.

Special sized units available within product size matrix. See your Integrity® retailer.

Multiple Assemblies

Multiple assemblies can be factory mulled.

MAXIMUM ROUGH OPENING not to exceed 114" X 78" Maximum up to 6 units wide by 1 unit high

MAXIMUM ROUGH OPENING not to exceed 96" X 96" Maximum up to 5 units wide by 5 units high

Field mull kits are available. Structural mullion reinforcement is required for some assemblies.

Please consult your local Integrity from Marvin® representative for more information.

DOUBLE HUNG Transoms and Multiple Assemblies

INTEGRITY® FROM MARVIN®
ALL ULTREX® SERIES

In-Sash Transom Mullered Over Double Hung – Operator Unit

Masonry Opening	2' - 6" (762)
Rough Opening	2' - 6" (762)
Frame Size	2' - 5 1/2" (749)
Glass Size	25 17/32" (649)

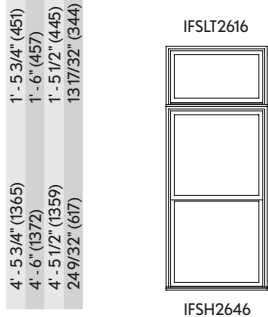

In-Sash Transom Mullered Over Double Hung – 2 wide Operator Unit

Masonry Opening	5' - 0" (1524)	2' - 6" (762)
Rough Opening	5' - 0" (1524)	2' - 6" (762)
Frame Size	4' - 11 1/2" (1511)	2' - 5 1/2" (749)

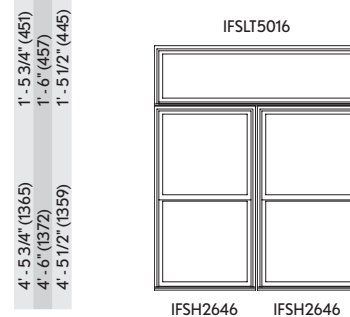

Double Hung Flankers with Picture Center Unit *

Masonry Opening	2' - 6" (762)	5' - 0" (1524)	2' - 6" (762)
Rough Opening	2' - 6" (762)	5' - 0" (1524)	2' - 6" (762)
Frame Size	2' - 5 1/2" (749)	4' - 11 1/2" (1511)	2' - 5 1/2" (749)

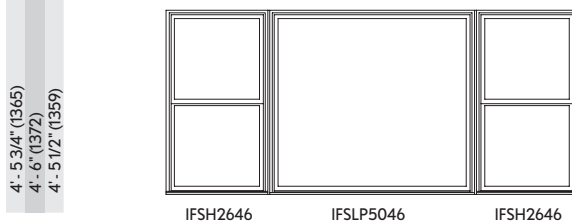

Double Hung Flankers with Operator Center Unit

Masonry Opening	2' - 6" (762)	2' - 6" (762)	2' - 6" (762)
Rough Opening	2' - 6" (762)	2' - 6" (762)	2' - 6" (762)
Frame Size	2' - 5 1/2" (749)	2' - 5 1/2" (749)	2' - 5 1/2" (749)
Glass Size	25 17/32" (649)	25 17/32" (649)	25 17/32" (649)

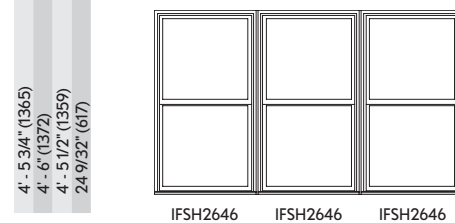

Construction Details

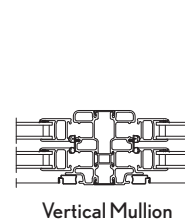
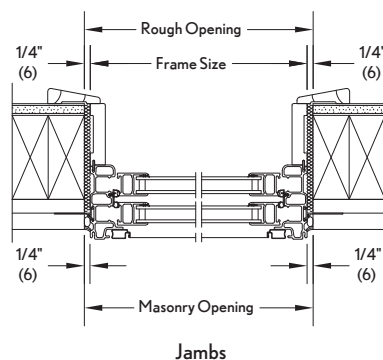
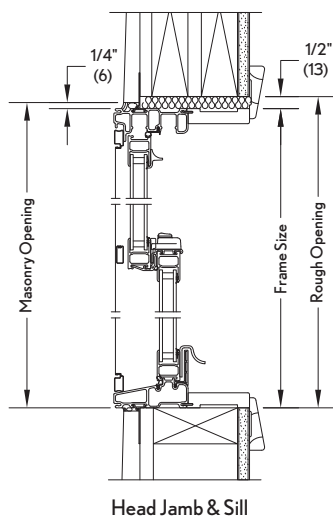

Vertical Mullion

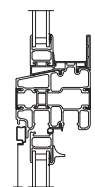

Horizontal Mullion
Transom/Operator

*This product is only available field mullered.

Details and Elevations not to scale.

Available in equal, cottage and reverse cottage sash configurations. Cottage and reverse cottage sash configurations are not available on 20, 60 and 66 call number heights.

Obscure Glass option available on all units.

Special sized units available within product size matrix. See your Integrity® retailer.

Multiple Assemblies

Multiple assemblies can be factory mullered.

MAXIMUM ROUGH OPENING not to exceed 114" X 78" Maximum up to 6 units wide by 1 unit high

MAXIMUM ROUGH OPENING not to exceed 96" X 96" Maximum up to 5 units wide by 5 units high









































































Field mull kits are available. Structural mullion reinforcement is required for some assemblies.

Please consult your local Integrity from Marvin® representative for more information.

SLIDING PICTURE UNITS

INTEGRITY® FROM MARVIN®
ALL ULTREX® SERIES

Picture Units

Masonry Opening	1'-6" (457)	2'-0" (610)	2'-6" (762)	2'-8" (914)	3'-0" (914)	3'-6" (1067)	4'-0" (1219)	5'-0" (1524)
Rough Opening	1'-6" (457)	2'-0" (610)	2'-6" (762)	2'-8" (914)	3'-0" (914)	3'-6" (1067)	4'-0" (1219)	5'-0" (1524)
Frame Size	1'-5 1/2" (445)	1'-11 1/2" (597)	2'-5 1/2" (749)	2'-7 1/2" (902)	2'-11 1/2" (902)	3'-5 1/2" (1054)	3'-11 1/2" (1207)	4'-11 1/2" (1511)
Glass Size	13 17/32" (344)	19 17/32" (496)	25 17/32" (649)	27 11/16" (804)	31 17/32" (801)	37 17/32" (953)	43 17/32" (1106)	55 17/32" (1411)
1'-11 3/4" (603) 2'-0" (610) 1'-11 1/2" (597) 2 11/32" (547)								
IFSLP1620	IFSLP2020	IFSLP2620	IFSLP2820	IFSLP3020	IFSLP3620	IFSLP4020	IFSLP5020	
2'-5 3/4" (756) 2'-6" (762) 2'-5 1/2" (749) 2 17/32" (699)								
IFSLP1626	IFSLP2026	IFSLP2626	IFSLP2826	IFSLP3026	IFSLP3626	IFSLP4026	IFSLP5026	
2'-11 3/4" (908) 3'-0" (914) 2'-11 1/2" (902) 3 17/32" (801)								
IFSLP1630	IFSLP2030	IFSLP2630	IFSLP2830	IFSLP3030	IFSLP3630	IFSLP4030	IFSLP5030	
3'-5 3/4" (1060) 3'-6" (1067) 3'-5 1/2" (1054) 3 17/32" (953)								
IFSLP1636	IFSLP2036	IFSLP2636	IFSLP2836	IFSLP3036	IFSLP3636	IFSLP4036	IFSLP5036	
3'-11 3/4" (1213) 4'-0" (1219) 3'-11 1/2" (1207) 4 3 17/32" (1106)								
IFSLP1640	IFSLP2040	IFSLP2640	IFSLP2840	IFSLP3040	IFSLP3640	IFSLP4040	IFSLP5040	
4'-5 3/4" (1365) 4'-6" (1372) 4'-5 1/2" (1359) 4 9 17/32" (1258)								
IFSLP1646	IFSLP2046	IFSLP2646	IFSLP2846	IFSLP3046	IFSLP3646	IFSLP4046	IFSLP5046	
4'-11 3/4" (1518) 5'-0" (1524) 4'-11 1/2" (1511) 5 5 17/32" (1411)								
IFSLP1650	IFSLP2050	IFSLP2650	IFSLP2850	IFSLP3050	IFSLP3650	IFSLP4050	IFSLP5050	
5'-5 3/4" (1670) 5'-6" (1676) 5'-5 1/2" (1664) 6 1 17/32" (1563)								
IFSLP1656	IFSLP2056	IFSLP2656	IFSLP2856	IFSLP3056	IFSLP3656	IFSLP4056	IFSLP5056	
5'-11 3/4" (1822) 6'-0" (1829) 5'-11 1/2" (1816) 6 7 17/32" (1715)								
IFSLP1660	IFSLP2060	IFSLP2660	IFSLP2860	IFSLP3060	IFSLP3660	IFSLP4060	IFSLP5060	

SLIDING PICTURE AND TRANSOM UNITS

In-Sash Transom

Masonry Opening	1' - 6" (457)	2' - 0" (610)	2' - 6" (762)	2' - 8" (914)	3' - 0" (914)	3' - 6" (1067)	4' - 0" (1219)	5' - 0" (1524)
Rough Opening	1' - 6" (457)	2' - 0" (610)	2' - 6" (762)	2' - 8" (914)	3' - 0" (914)	3' - 6" (1067)	4' - 0" (1219)	5' - 0" (1524)
Frame Size	1' - 5 1/2" (445)	1' - 11 1/2" (597)	2' - 5 1/2" (749)	2' - 7 1/2" (902)	2' - 11 1/2" (902)	3' - 5 1/2" (1054)	3' - 11 1/2" (1207)	4' - 11 1/2" (1511)
Glass Size	13 17/32" (344)	19 17/32" (496)	25 17/32" (649)	27 11/16" (804)	31 17/32" (801)	37 17/32" (953)	43 17/32" (1106)	55 17/32" (1411)

0' - 11 3/4" (298)								
1' - 5 3/4" (451)								
1' - 11 3/4" (603)								

Construction Details

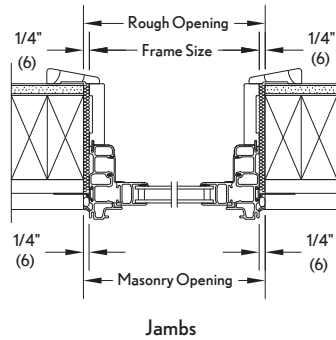
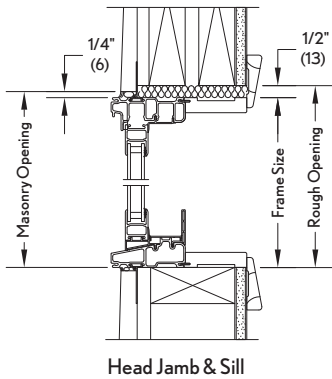

GBG available in standard Rectangular lite cut, shown. (Not available on In-Sash Transom units.)

Details and Elevations not to scale.

Multiple Assemblies

Multiple assemblies can be factory mullied.

MAXIMUM ROUGH OPENING not to exceed 114" X 78" Maximum up to 6 units wide by 1 unit high

MAXIMUM ROUGH OPENING not to exceed 96" X 96" Maximum up to 5 units wide by 5 units high

Field mull kits are available. Structural mullion reinforcement is required for some assemblies.

Please consult your local Integrity from Marvin® representative for more information.